

LH

HIGH HEAD DRAINAGE PUMPS



Submersible High Head Drainage Pumps

Tsurumi LH/LH-W series pumps are submersible heavy-duty pumps specialized for high head. These pumps are available in a wide lineup, offering 3 to 110kW motor output and 18 to 230m maximum head. The LH/LH-W series has played an active role in various fields, from small/medium-scale civil engineering and construction work that requires high reliability, to large-scale projects for constructing tunnels, bridges and dams. And, because of the slim body, these pumps have particularly helped to drain mine pits where required to work in limited space.

So that they can stand up to harsh environment, these pumps have the impeller and mouth ring made of high-chromium cast iron that provides high wear resistance. The pump is equipped with seal pressure relief ports* that release pump pressure applied to the mechanical seal. Furthermore, to endure even extended operation at low water level, these pumps feature flow-thru design that forcibly cools down the motor. With these features, Tsurumi pumps provide excellent reliability and durability that enables continuous duty for long periods of time.

* excluding 3kW

Available as optional specifications are a proprietary “seawater-resistant pump” developed over many years by Tsurumi to enable seawater intake/drainage for long periods of time, and an “all stainless steel pump” using 316 stainless steel for mining markets.



LH: Lineup of pumps with high head in consideration of discharge volume.

LH-W: Comprised of dual impellers for extra high head.

Selection Table

LH (Single Impeller)	3kW		★			
	15kW					
	19kW					
	22kW					
	30kW					
	37kW					
	45kW					
	55kW					
	75kW					
	90kW					
110kW						
Discharge Bore		2"	3"	4"	6"	8"
		50mm	80mm	100mm	150mm	200mm
LH-W (Dual Impellers)	3kW	★				
	5.5kW	★				
	11kW		★			
	22kW		★			
	30kW			★		
	110kW					

★ Tandem operation model: Same model pumps are connected in series, to deliver higher head.

Model Number Designation

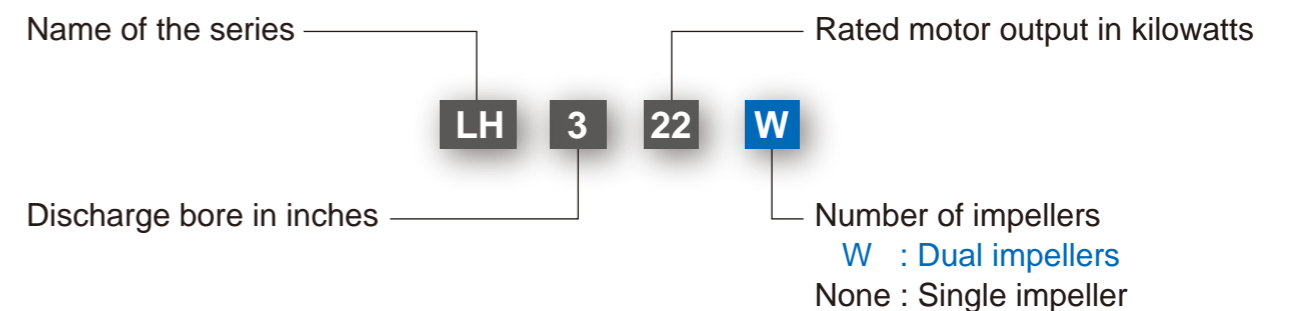

Options

- Seawater-resistant version;
 - High temperature liquids version;
 - High voltage version;
 - All stainless steel version;
- Galvanic anode & Special impeller
Max. 90°C
Max. 1000V
316 S.S.

Top Discharge, Flow-thru Design

This design provides maximum motor cooling efficiency allowing continuous operation at low water levels and extended dry-run capability, and also allows the shape of the pump to be cylindrical and slim for installation in a well casing for deep well dewatering.

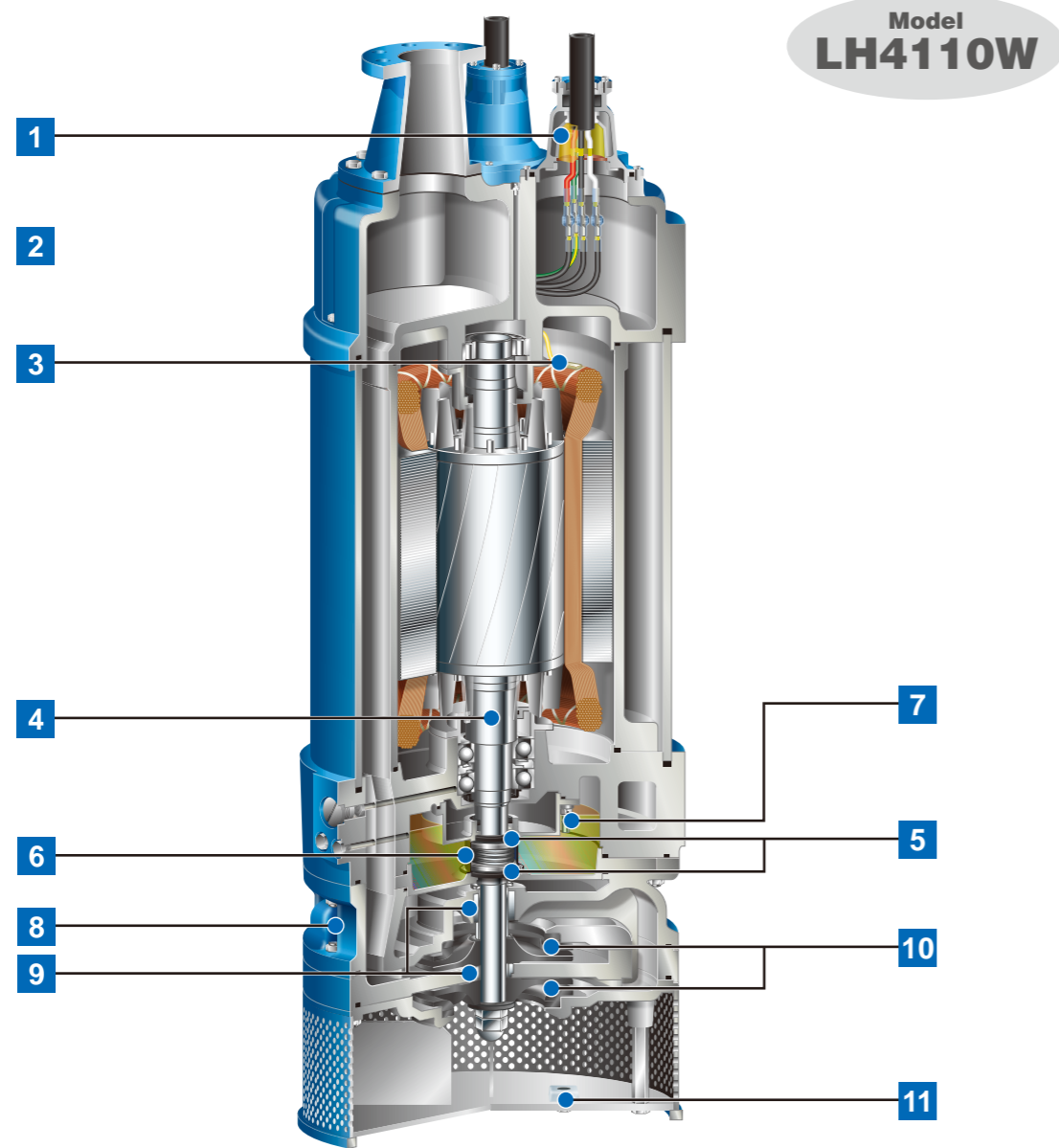

1 Anti-wicking Cable Entry

Prevents water incursion due to capillary wicking should the power cable be damaged or the end submerged.

2 Cable Clip

Prevents unexpected water incursion that can occur if the cable is damaged, by protecting the cable against the tugging and rough handling found at construction sites.

3 Motor Protector

Circle Thermal Protector (22kW and below)

Directly cuts the motor circuit if excessive heat builds up or overcurrent occurs in the motor.

Miniature Thermal Protectors (30kW and above)

React to excessive heat caused by dry-running. The bimetal strip opens to cause the control panel to shut the power supply.

4 Shaft

Quenching treatment is applied to parts that contact particles in pumped fluids and whose mechanical seal may wear out, to enhance surface hardness and extend shaft service life.

5 Dual Inside Mechanical Seals with Silicon Carbide Faces

Isolated in the oil chamber where a clean, non-corrosive and abrasion-free lubricating environment is maintained. Compared with the water-cooled outside mechanical seal, it reduces the risk of failure caused by dry-heating and adhering matter. The Silicon carbide provides 5 times higher corrosion, wear and heat resistance than the tungsten carbide. Rubber parts of the upper and lower fixing rings are made of NBR or FPM (FKM), which provides higher resistance to heat and chemicals.

Options

Seawater-Resistant Version

Tsurumi's pumps can be combined with a seawater-resistant kit (optional) that adds a "galvanic anode" and "seawater-resistant special cast iron impeller," and enables about two years of service. (The service period depends on operating conditions.) For details, refer to the Seawater-Resistant Pumps catalog [IB115].



High Temperature Liquids Version

Tsurumi's pumps are applicable to high temperature liquids of up to 90°C. Pumps of the standard specification can discharge liquids of up to 40°C. However, there are many fields that need to discharge higher temperature liquids, e.g., discharging industrial water from a power plant or ironworks, or discharging hot spring water from a mine in a volcanic zone.

High Voltage Version

Tsurumi's pumps can be fabricated to 690V or 1000V ratings that are often required for mining applications. The pumps meet mining safety standards as they come with shielded cables and motors with built-in diodes for ground-fault checks.

All Stainless Steel Version

All of the parts of Tsurumi's pumps that contact fluid, including the impeller, pump casing, motor frame, outer cover, strainer stand, and flange, can be made in 316 stainless steel. Tsurumi's all stainless steel pump can handle corrosive fluids generated in mines or quarries, and fluids of low pH value.



6 Oil Lifter [Patented]

Provides lubrication and cooling of the seal faces down to 1/3 of normal oil level, thus maintaining a stable shaft sealing effect and prolonging seal life longer.

7 Leakage Sensor (55kW and above)

Detects flooding into the oil chamber that may occur in a worst case scenario. When flooding is detected, signals are sent to operate the indicator lamps through the external control panel.

8 Seal Pressure Relief Ports (excluding 3kW)

Protect the mechanical seal from pump pressure. They also protect the seal face by discharging wear particles.

9 Labyrinth Ring (LH 15kW and above & LH-W)

Equipped to provide a better countermeasure against wear caused by high pressure generated in the casing and improve the maintainability.

10 High-chromium Cast Iron Closed Impeller & Mouth Rings

Resists wear caused by abrasive particles and enables the pump to maintain its original performance for an extended period of time.
LH: Single impeller LH-W: Dual impellers

11 Galvanic Anodes (excluding 3kW)

Protect the pump against corrosive potential generated during the drainage of wastewater.

LH -Single Impeller-

The LH-series is a submersible three-phase cast iron high head drainage pump. Being the pump cylindrical and slim, it can be installed in a well casing for deep well dewatering. The center flange construction assures a stable installation even if it is fixed by the discharge pipe. The top discharge, flow-thru design provides maximum motor cooling efficiency allowing continuous operation at low water levels and extended dry-run capability. The pump incorporates seal pressure relief ports that prevent the pumping pressure from applying to the shaft seal.*

* excluding LH33.0



Discharge Bore mm	Model	Motor Output kW	Phase	Starting Method	Solids Passage mm	Dimensions L x H mm	Dry Weight* ² kg	Cable Length m
80	LH33.0	3	Three	D.O.L.	6	185 x 645	42	20
100	LH422	22		D.O.L.* ¹	6	420 x 1352	350	10
100	LH430	30		Star-Delta	6	420 x 1352	355	10
150	LH615	15		D.O.L.* ¹	8.5	330 x 1014	213	10
150	LH619	19		D.O.L.* ¹	12	420 x 1423	350	10
150	LH622	22		D.O.L.* ¹	12	420 x 1423	360	10
150	LH637	37		Star-Delta	6	530 x 1448	495	10
150	LH645	45		Star-Delta	6	530 x 1448	510	10
150	LH675	75		Star-Delta	8	563 x 1676	865	10
150	LH690	90		Star-Delta	10	592 x 1787	1100	20
150	LH6110	110		Star-Delta	10	592 x 1787	1200	20
200	LH837	37		Star-Delta	20	530 x 1448	495	10
200	LH845	45		Star-Delta	20	530 x 1448	510	10
200	LH855	55		Star-Delta	20	563 x 1716	810	10
200	LH875	75		Star-Delta	20	563 x 1716	865	10
200	LH890	90		Star-Delta	20	592 x 1787	1150	20
200	LH8110	110		Star-Delta	20	592 x 1787	1250	20

*¹ Star-Delta available upon request

*² Weights excluding cable

Performance Curves

< 80-100mm >

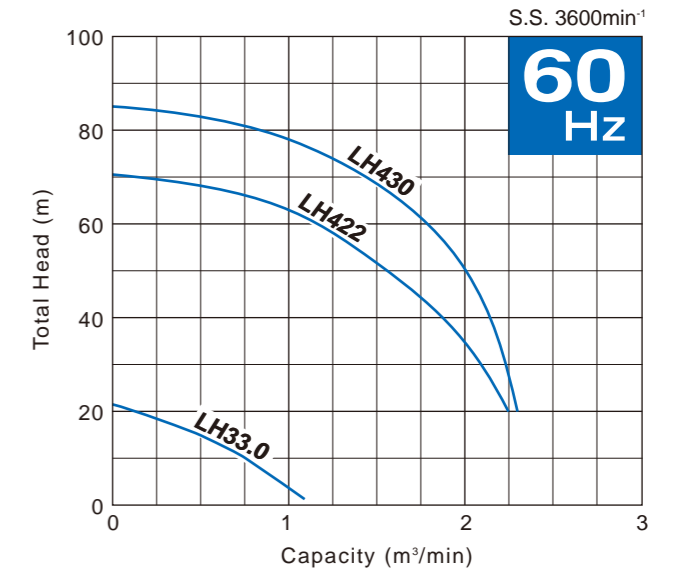
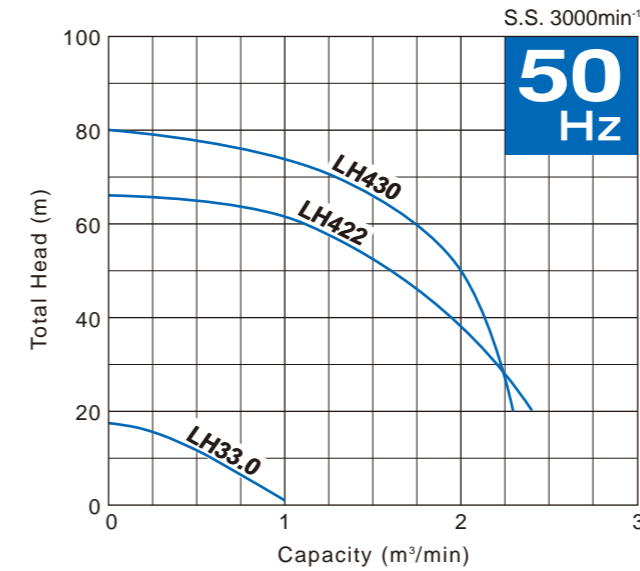

< 150mm >

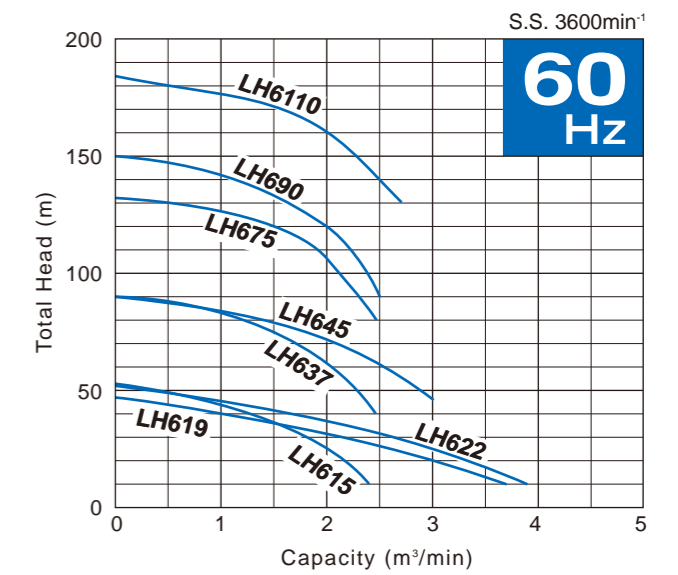
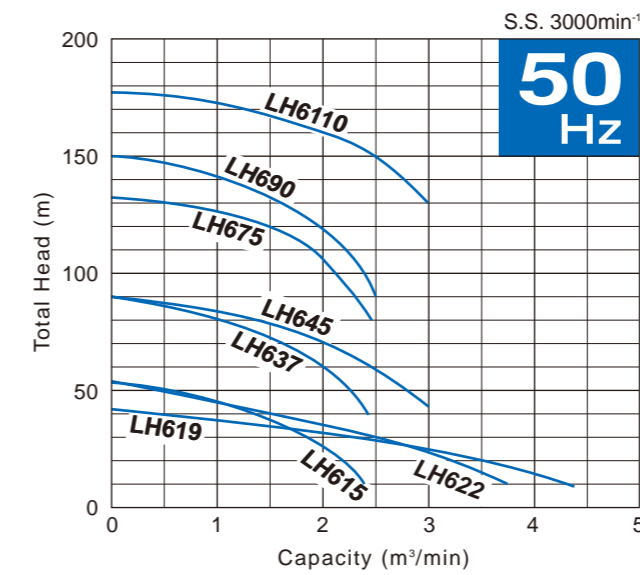

< 200mm >

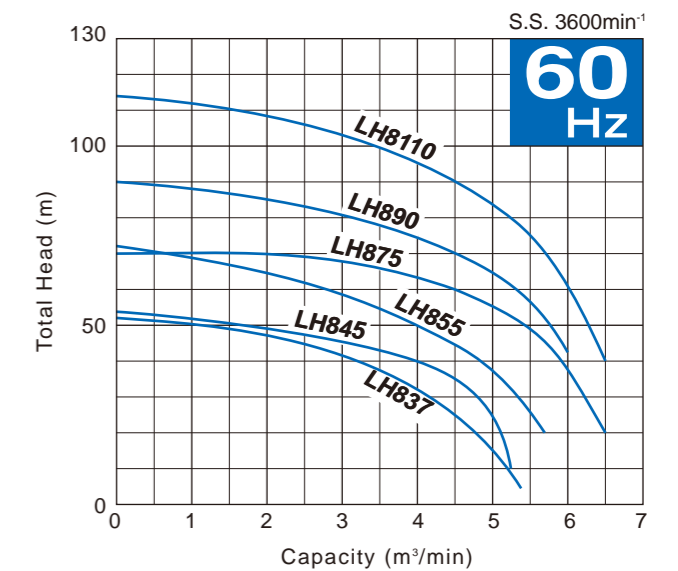
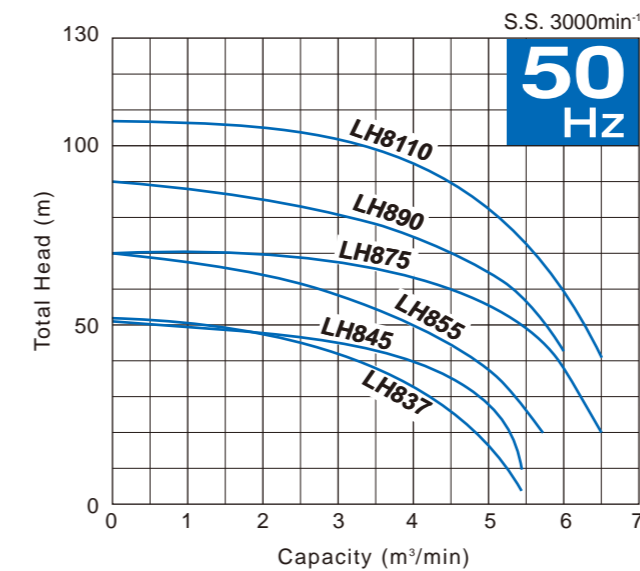

LH-W –Dual Impellers–

The LH-W-series is a submersible three-phase cast iron extra high head drainage pump having dual impellers. Being the pump cylindrical and slim, it can be installed in a well casing for deep well dewatering. The center flange construction assures a stable installation even if it is fixed by the discharge pipe.*¹ The top discharge, flow-thru design provides maximum motor cooling efficiency allowing continuous operation at low water levels and extended dry-run capability. The pump incorporates seal pressure relief ports that prevent the pumping pressure from applying to the shaft seal.*²

*¹ excluding LH4110W

*² excluding LH23.0W



LH23.0W

LH311W

LH4110W

Discharge Bore mm	Model	Motor Output kW	Phase	Starting Method	Solids Passage mm	Dimensions L x H mm	Dry Weight* ² kg	Cable Length m
50	LH23.0W	3	Three	D.O.L.	6	185 x 630	46	20
50	LH25.5W	5.5		D.O.L.* ¹	6	254 x 750	80	20
80	LH311W	11		D.O.L.* ¹	8.5	270 x 1024	130	20
80	LH322W	22		D.O.L.* ¹	8.5	330 x 1235	304	20
100	LH430W	30		Star-Delta	8.5	365 x 1375	324	20
100	LH4110W	110		Star-Delta	8	616 x 1825	1270	20

*¹ Star-Delta available upon request

*² Weights excluding cable

Performance Curves

< 3-30kW >

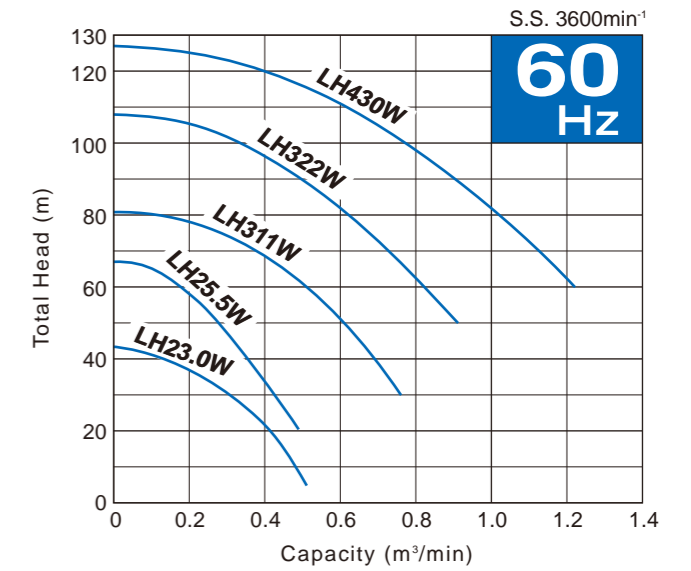
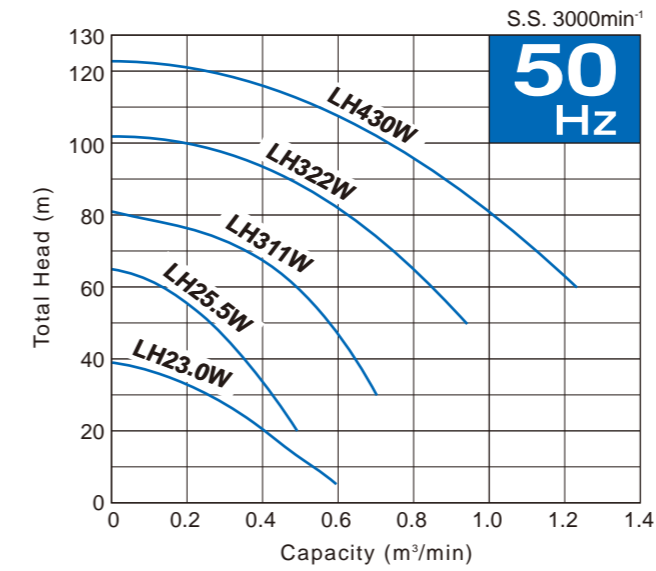

< 110kW >

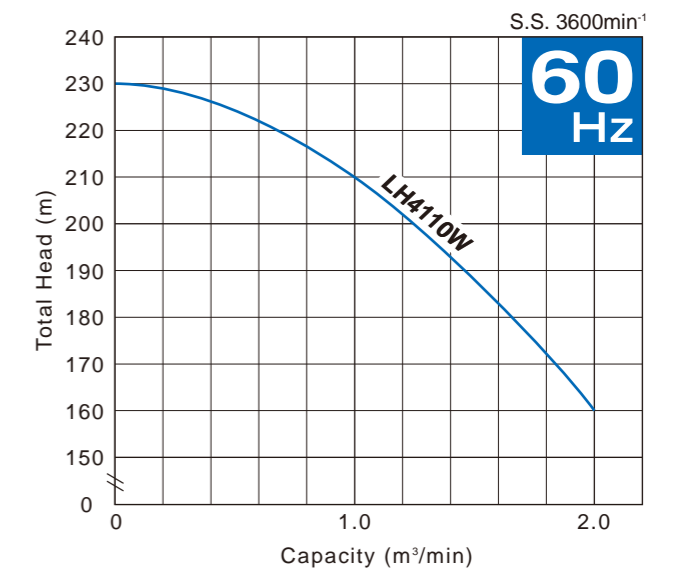
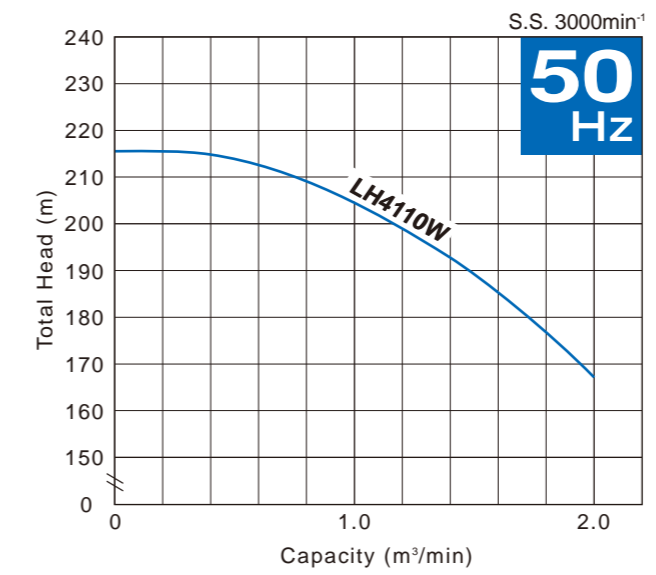

Tandem Operation

“Tandem operation” is an operation method that connects two pumps of the same model in series. This provides double pump head at the same flow rate in comparison with that of a single pump. The principle of tandem operation is the same as that with multistage pumps.

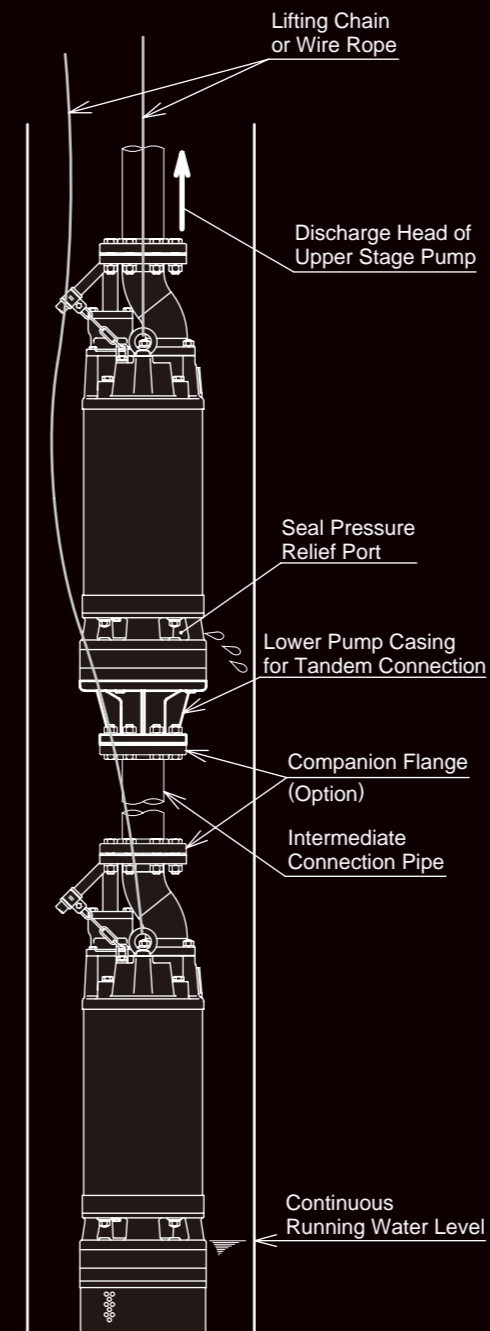

Precautions for Selection and Use

For model selection, piping and installation procedure, be sure to consult Tsurumi distributors in advance.

1. If the required total head exceeds the maximum head of the pump without the intermediate connection pipe shown in the selection table, insert an intermediate connection pipe of a length corresponding to the excess amount or more, to reduce the pressure applied to the pump in the upper stage.
2. Check the approximate weight of one pump and the allowable load for two eyebolts (per pump) shown in the selection table, and determine the piping weight, installation method and lifting procedure so that the allowable load is not exceeded.
3. The pump in the lower stage should be installed at the bottom of the vertical hole, unless special measures are taken. Do not suspend the pump in midair. Do not allow the weight of the upper pump and piping to be applied to the lower pump.
4. Since a certain amount of water spouts from the seal pressure relief port,* both the upper- and lower-stage pumps should be installed in the vertical hole. Do not use the pumps as booster pumps in the middle of a horizontal line lying on the ground.
* excluding LH33.0 and LH23.0W
5. Do not connect pumps of different models in series. Do not use either of two connected pumps singly. Failure to observe these instructions may change the operating point improper, resulting in trouble.

Tandem Operation -LH / LH-W-

“Tandem operation” is an operation method that connects two pumps of the same model in series. This provides double pump head at the same flow rate in comparison with that of a single pump. The principle of tandem operation is the same as that with multistage pumps. The LH and LH-W series pumps adopt the center flange construction to align the discharge pipe with the cylindrical pump center axis.* Connecting the pumps in series with the tandem connector can provide higher pump head without affecting the advantage of the slim design. At construction sites, there are many cases where a higher pump head is required as construction work progresses. In such cases, the addition of a tandem pump may meet the required pump head, instead of using a new pump.

* Available as an option for separately purchased LH33.0 and LH23.0W.



LH23.0W
for Tandem Operation

Discharge Bore mm	Model	Motor Output kW	Starting Method	Max. Head in Tandem m	Max. Head w/o Intermediate Connection Pipe m	Dimensions L x H mm	Dry Weight *2 kg	Allowable Load on Eyebolts kg	Cable Length m
80	LH33.0	3	D.O.L.	36 / 44	33	185 x 731	54	150	20
50	LH23.0W	3	D.O.L.	78 / 86	50	185 x 759	59	150	20
50	LH25.5W	5.5	D.O.L.*1	130	97.5	254 x 808	96	220	20
80	LH311W	11	D.O.L.*1	162	121.5	270 x 1043	125	450	20
80	LH322W	22	D.O.L.*1	204 / 216	162	330 x 1255	365	950	20
100	LH430W	30	Star-Delta	246 / 254	190.5	365 x 1400	389	950	20

*1 Star-Delta available upon request

*2 Weights excluding cable

Performance Curves

The intermediate connection pipe is not required in the range indicated as a bold line on curves. If the required total head exceeds the maximum head of the pump without an intermediate connection pipe (indicated as dashed line), an intermediate connection pipe of a length corresponding to the excess amount or more is required.

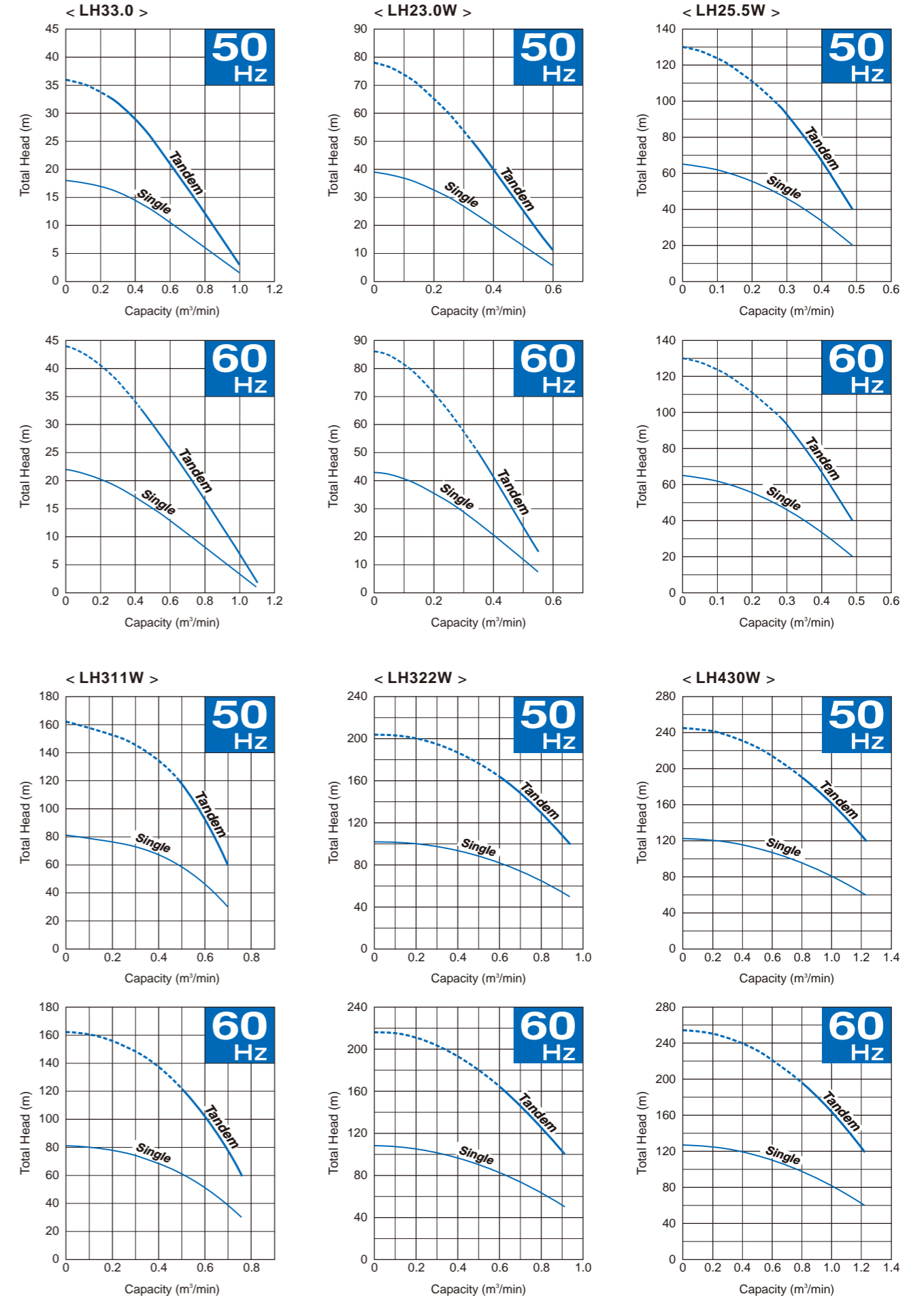

Specifications

		LH											LH						LH-W											
		LH33.0	LH422	LH430	LH615	LH619	LH622	LH637	LH645	LH675	LH690	LH6110							LH837	LH845	LH855	LH875	LH890	LH8110	LH23.0W	LH25.5W	LH311W	LH322W	LH430W	LH4110W
PUMP	Discharge Bore	mm	80	100		150							200						50		80		100							
	Discharge Connection	Threaded Hose Connector	JIS 10kg/cm ² Flange						JIS 20kg/cm ² Flange					JIS 10kg/cm ² Flange						Threaded Hose Connector	JIS 10kg/cm ² Flange			JIS 20kg/cm ² Flange						
	Solids Passage	mm	6		8.5	12		6	8	10			20						6		8.5		8							
	Impeller		Semi-open	Closed											Closed						Semi-open (Dual)	Closed (Dual)			Closed (Dual Back-to-back)					
				High-chromium Cast Iron											High-chromium Cast Iron															
	Mouth Ring		—	High-chromium Cast Iron											High-chromium Cast Iron						—	High-chromium Cast Iron								
	Labyrinth Ring		—	304 Stainless Steel						403 Stainless Steel					304 Stainless Steel			403 Stainless Steel			304 Stainless Steel			630 Stainless Steel						
	Casing		Gray Cast Iron / Ductile Cast Iron												Gray Cast Iron / Ductile Cast Iron															
	Shaft Seal		Dual Inside Mechanical Seals (with Oil Lifter)												Dual Inside Mechanical Seals (with Oil Lifter)															
			Silicon Carbide												Silicon Carbide															
Shaft Sleeve		403 Stainless Steel											403 Stainless Steel						630 Stainless Steel											
Galvanic Anode		—	Aluminium Alloy											Aluminium Alloy						—	Zinc		Aluminium Alloy							
MOTOR	Type	Continuous-duty Rated, Dry-type Induction Motor												Continuous-duty Rated, Dry-type Induction Motor																
	Output	kW	3	22	30	15	19	22	37	45	75	90	110	37	45	55	75	90	110	3	5.5	11	22	30	110					
	Phase	Three												Three																
	Pole	2												2																
	Insulation		F	B	F	B			F					F						B			F							
	Starting Method		D.O.L.		Star-Delta		D.O.L.			Star-Delta					Star-Delta						D.O.L.			Star-Delta						
	Motor Protector (built-in)		CTP		MTP		CTP			MTP					MTP						CTP			MTP						
	Leakage Sensor (built-in)		—						Electrode					—	Electrode					—			Electrode							
	Lubricant	ml	380	6900		3740	6900		4800	6100	8000			4800	6100		8000		380	720	800	2350			7800					
			Turbine Oil (ISO VG32)												Turbine Oil (ISO VG32)															
Shaft		420 Stainless Steel												420 Stainless Steel																
Cable	m	20	10						20					10						20										
		Chloroprene Rubber												Chloroprene Rubber																
Dry Weight*	kg	42	350	355	213	350	360	495	510	865	1100	1200	495	510	810	865	1150	1250	46	80	130	304	324	1270						

* Weights excluding cable



We reserve the right to change the specifications and designs for improvement without prior notice.

**TSURUMI
MANUFACTURING CO., LTD.**

Your Dealer